

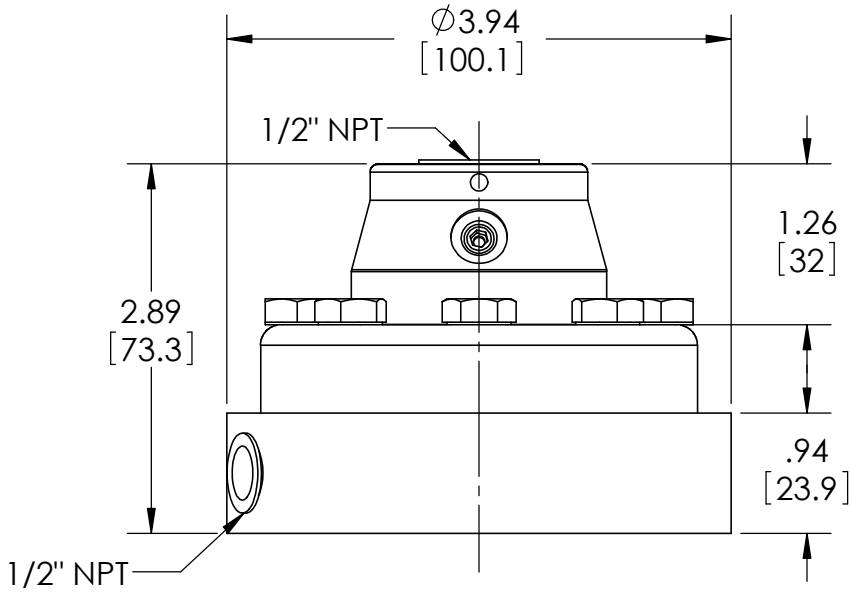

This drawing includes confidential information which is the property of ASHCROFT INC. This copy is loaned for a specific purpose, with the understanding that it will not be reproduced or used for any other purpose or disclosed to others, and it will be returned on demand.

**ASHCROFT** INC.

250 EAST MAIN STREET  
STRATFORD, CT 06614

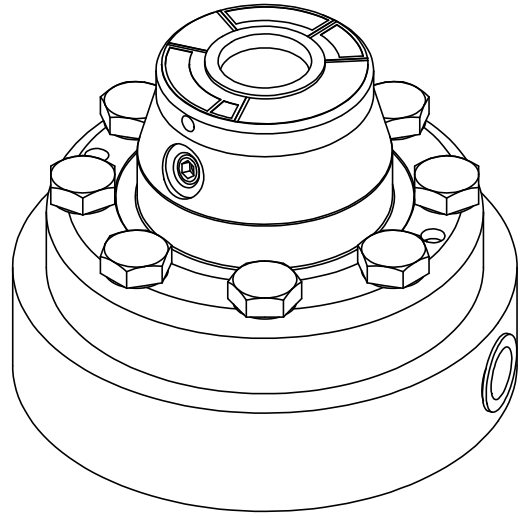
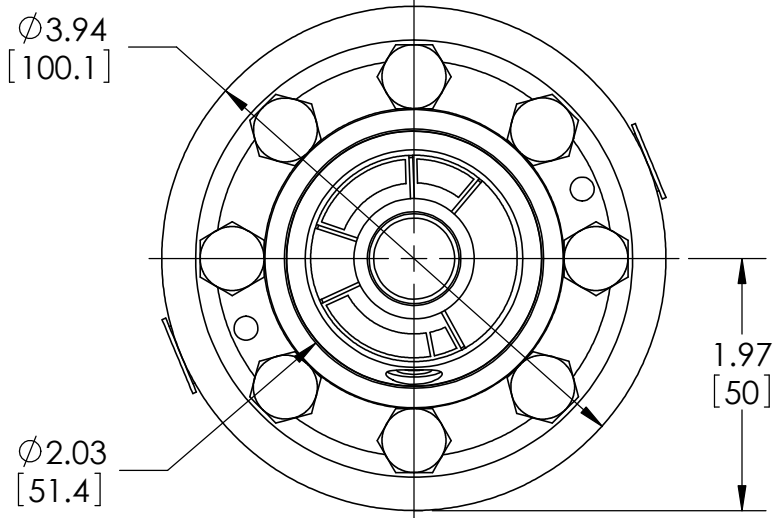

DIMENSIONS IN [ ] ARE MILLIMETERS

REV.	ECO	DESCRIPTION	BY	DATE
A	0005001	RELEASED GENERAL DIMS.	MJS	9/17/2010

This print certified correct for		<b>General Dimensions</b>			
Customer's Name		TYPE: 104, 204, 304			
		PROCESS CONN: 1/2" - INSTRUMENT CONN: 1/2" NPT			
		IN-LINE THREADED DIAPHRAGM SEAL			
Customer's Order No.		Drawn MJS	Date 9/17/10	Date of Issue	
Ashcroft Order No.		Checked	Date	SHEET-1	Rev.
Certified by	Date	Approved	Date	<b>70A3151</b>	<b>A</b>