

Choosing a temperature sensor to meet your application requirements can be an overwhelming task.

This guide breaks down the method to select an Ashcroft[®] RTD or a thermocouple sensor into detailed steps. Each step provides a thorough explanation of the choices to assist you in selecting the best sensor part number configuration for your specific application.

There are a few configuration types to review before building a part number for your application:

1. The first is to decide whether your application needs an **RTD or Thermocouple**. Both RTDs and thermocouples are sensors used to measure temperature and the choice of which one to use should be based on the application requirements. Each sensor has its own advantages and disadvantages depending upon the application conditions:
 - In general, RTDs are more accurate, stable, and linear within a temperature range up to 600 °C (1112 °F). RTD sensors are better suited to lower temperature ranges, where higher accuracy, stability and repeatability is required.
 - In contrast, thermocouples are more cost-effective, less accurate, less stable and can drift over time. However, thermocouples have a faster temperature response, are more rugged and can withstand harsher conditions, such as vibration and temperatures up to and over 2000 °C (3632 °F), depending on the thermocouple type.
2. Next you will need to decide if you need a **direct mount assembly or a remote mount assembly**. Remote mount assemblies are used when it is not ideal to have the head/transmitter directly mounted on the probe when vibration, high temperature or accessibility is an issue.

Direct Mount Assemblies

Ashcroft[®] RTD and thermocouple direct mount assemblies offer an extensive range of RTD elements or thermocouple types, connection heads, insertion lengths and process connections. Additionally, we offer a variety of 4-20 mA transmitters hockey puck style in the connection heads as well as transmitters with displays. Replacement sensors can also be configured for these models. [The Ashcroft[®] S50 RTD and thermocouple](#) are the most popular models tailored for direct mount, designed with nipple or nipple-union-nipple that can be direct mounted to the process or with a thermowell depending on the application.

Remote Mount Assemblies

Ashcroft[®] RTD and thermocouple remote mount assemblies also offer the same features as direct mount assemblies with cables between the probe and the connection head to isolate the electronics from the high temperature environments and vibration. [Ashcroft[®] S80 thermocouple](#) and [S81 RTD assemblies](#) are the most popular assemblies tailored for remote mount applications, designed with various fittings to be direct mounted to the process or with a thermowell depending on the application.

This guide is divided into four sections, each with a detailed explanation on the part number configuration requirements:

Table of Contents	Page
1) S50 Direct Mount RTD Sensor	5 - 11
2) S50 Direct Mount Thermocouple Sensor	12 - 19
3) S80 Remote Mount Thermocouple Sensor	20 - 28
4) S81 Remote Mount RTD Sensor	29 - 38

Please refer to the appropriate section to configure the right sensor for your application.

Thank you for choosing Ashcroft for your temperature measuring applications!

Contact us to help you with your next project:

 1.800.328.8258

 ashcroft.com

1) S50 Direct Mount RTD Sensor

Selection Example:

	Model type	Location	Sheath Diameter	Resistance	Accuracy	Temperature Range	Wiring Configuration	Sheath Material	Head Type	Connection	Cable Glands	Nominal Length	Lag Extension	Process Connection	Electrical Connection	Certification	Calibration Certificate	Tag	N=xxx LN=xxx	
Ordering Code	S50	1	T	1																
Step	1	2	3	4	5	6	7	8	9	10	11	12	13	14	15	16	17	18	19	

1 The product code configuration starts with the model type.

Code	RTD Series
S50	Direct Mount RTD Sensor

2 Select whether the sensor is used in a hazardous location or non-hazardous location.

If it is a hazardous location, select the method of protection you will need for the assembly. Later in the configuration (Step 16) you will need to decide which agency certificate is required.

Code	Area Classification
1	Standard – General purpose applications
3	Intrinsic Safety – ia – FM, ATEX or IECEx certificate available
B	Intrinsic Safety – ib – ATEX or IECEx certificate available
E	Increased Safety – ATEX certificate available
2	Explosion Proof (requires F or S Head Type) – FM, ATEX or IECEx certificate available
N	Non-Incendive – FM certificate available

3 Select the sheath diameter, which is also known as stem diameter.

It is critical to ensure that the probe will fit in the application nozzle or thermowell bore diameter. A typical thermowell has a 0.260" bore diameter that will perfectly fit a ¼" sheath diameter.

Code	Sheath Diameter
T	¼" (6.35 mm)
S	3/16" (4.76 mm)
R	1/8" (3.18 mm) – single RTD sensor only
3	3 mm – single RTD sensor only
4	4.5 mm
6	6 mm
8	8 mm

4 Select the the RTD resistance.

Typically, the Pt 100 (100 ohm) is the most popular sensor, but the Pt 1000 (1000 ohm) can be used interchangeably depending on the instrument used. In some instances, the Pt 1000 will have better performance and accuracy.

Code	RTD Type
1	Pt 100 Platinum 385 temperature coefficient
3	Pt 1000 Platinum 385 temperature coefficient

Selection Example:

	Model type	Location	Sheath Diameter	Resistance	Accuracy	Temperature Range	Wiring Configuration	Sheath Material	Head Type	Connection	Cable Glands	Nominal Length	Lag Extension	Process Connection	Electrical Connection	Certification	Calibration Certificate	Tag	N=xxx Ln=xxx	
Ordering Code	S50	1	T	1	B	A														
Step	1	2	3	4	5	6	7	8	9	10	11	12	13	14	15	16	17	18	19	

5 Select the appropriate accuracy for your application requirements.

RTDs accuracy Class A and Class B are the most common accuracy classes. The accuracy class has an associated temperature range for either the wire wound or thin film RTD selected in the next step.

Code	RTD Accuracy or Class (IEC 60751)
A	Class A ((Thin film resistor -30 to 300 °C (-22 to 572 °F)), ((wire wound -100 to 450 °C (-148 to 842 °F))
B	Class B 0 to 400 °C ((Thin film resistor -50 to 500 °C (-58 to 930 °F)), ((wire wound -196 to 600 °C (-320 to 1112 °F))
C	½ DIN
D	Class AA - ⅓ DIN

Accuracy Class

RTDs - (IEC 60751)

Class A: $\pm(0.15 + 0.0020 * |t|)$

Class B: $\pm(0.30 + 0.0050 * |t|)$

½ Class B: $\pm(0.15 + 0.0025 * |t|)$

⅓ Class B: $\pm(0.10 + 0.0017 * |t|)$

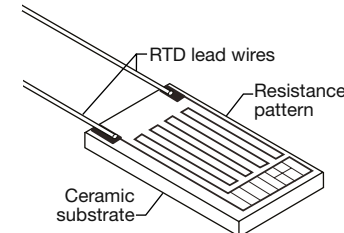

Thin Film RTD

Class B -50 °C to 500° C (-58 °F to 930 °F)
 Class A -30 °C to 300° C (-22 °F to 572 °F)
 Class AA 0 °C to 150° C (32 °F to 302 °F)

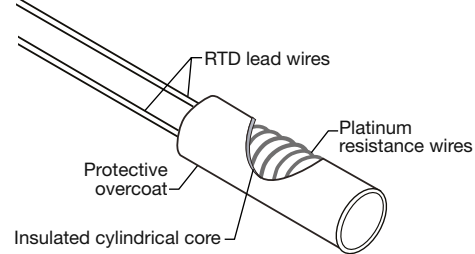

Wire Wound

Class B -196 °C to 600° C (-320 °F to 1112 °F)
 Class A -100 °C to 450° C (-148 °F to 842 °F)
 Class AA -50 °C to 250° C (-58 °F to 482 °F)

6 Select the operating temperature range.

If the temperature range is -50 °C to 400 °C, you should select the thin film resistor for best results. However, if the temperature range is -200 °C to 600 °C, then a wire wound resistor would be best.

Code	RTD Element/Range
A	-50 °C to 400° C (thin film resistor)
B	-200 °C to 600° C (wire wound resistor)
D	Vibration-proof (wire wound resistor)

Selection Example:

	Model type	Location	Sheath Diameter	Resistance	Accuracy	Temperature Range	Wiring Configuration	Sheath Material	Head Type	Connection	Cable Glands	Nominal Length	Lag Extension	Process Connection	Electrical Connection	Certification	Calibration Certificate	Tag	N=xxx LN=xxx	
Ordering Code	S50	1	T	1	B	A	B													
Step	1	2	3	4	5	6	7	8	9	10	11	12	13	14	15	16	17	18	19	

7 Select wiring configuration and whether it is a single or dual sensor probe.

It's important to select the correct RTD wire configuration because it will impact system accuracy.

2-Wire Connection

2-wire RTD configuration is the least accurate since wire resistance is included in the measurement. 2-wire RTDs are usually used with short lead wires or where accuracy is not essential. The wire resistance R2 and R3 are in the measured value.

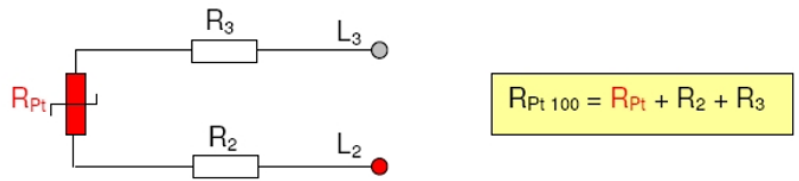

3-Wire Connection

3-wire configuration is the most used in industrial applications where the third wire provides a method for removing the average lead wire resistance from the measurement. Only if the wire resistance R1, R2 and R3 are equal do you measure the true PT 100 resistance

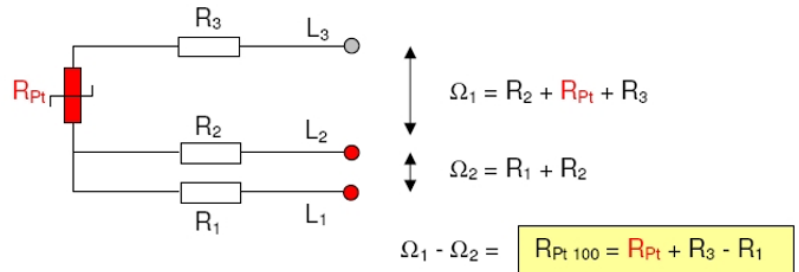

4-Wire Connection

4-wire configuration cancels lead wire resistance error. 4-wire construction is used primarily for laboratory applications where close accuracy is required. The current source will maintain the excitation current constantly (0.1-1mA). Following Ohm' law, $R=V/I$, the resistance can be calculated. The digital volt meter, DVM, has an input impedance of at least 10 Mohms. Thus just an extremely small current will pass through the DVM which means that the voltage drops over the wire resistances R2 and R3 will be practically none.

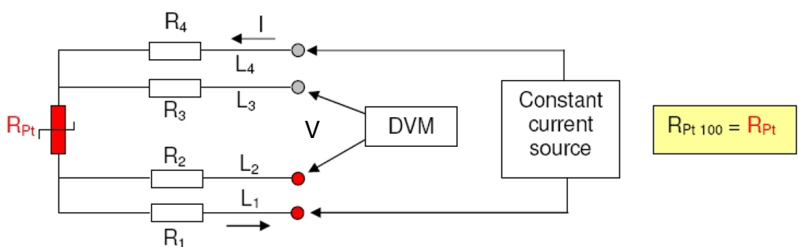

Code	Single/Dual
A	Single 2-wire
B	Single 3-wire
C	Single 4-wire
D	Dual 2-wire
E	Dual 3-wire
F	Dual 4-wire

Selection Example:

	Model type	Location	Sheath Diameter	Resistance	Accuracy	Temperature Range	Wiring Configuration	Sheath Material	Head Type	Connection	Cable Glands	Nominal Length	Lag Extension	Process Connection	Electrical Connection	Certification	Calibration Certificate	Tag	N=xxx LN=xxx	
Ordering Code	S50	1	T	1	B	A	B	A	N											
Step	1	2	3	4	5	6	7	8	9	10	11	12	13	14	15	16	17	18	19	

8 Select sheath material.

316 stainless steel is standard for RTD sheath material. If an exotic material is desired, we recommend that it be used on the thermowell for process comparability such as caustic media. To select the thermowell for your RTD, you can view the available options and configure the appropriate product part number [here](#).

Code	Sheath Material
A	316 Stainless steel, AISI 316/ 1.4404

9 Select head type.

The head type head should meet application environment and approvals restrictions. For example, only Ex d aluminum and Ex d stainless steel head type can be used when FM explosion proof approval is required.

S50 Head Selection

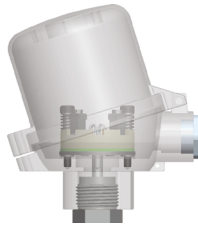

BUZH-AL
Type E

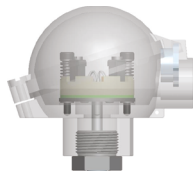

BUZH-AL
Type D

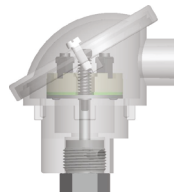

DIN B
Type B

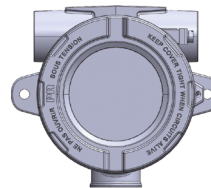

PR 7501 with display
Type P

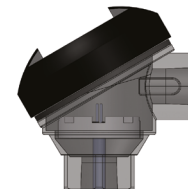

Cast Iron
Type Y

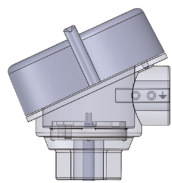

Type F Ex d-AL
Type S Ex d-Stainless Steel

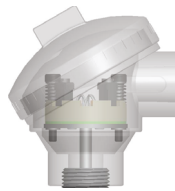

SCCA-AL
Type N

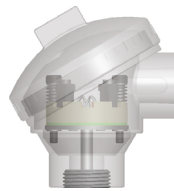

SCCI-Stainless Steel
Type G

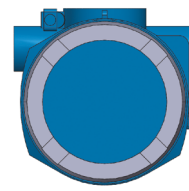

E&H Display Housing
Type H

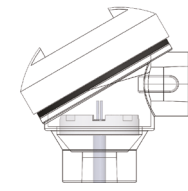

Polypropylene
Type A

Code	Head Type
E	BUZH aluminum
D	BUZ aluminum
B	DIN B aluminum
P	PR 7501
Y	Cast iron
F	Ex d aluminum
S	Ex d stainless steel
N	SCCA aluminum
G	SCCI stainless steel
H	E&H housing
A	Polypropylene

Selection Example:

	Model type	Location	Sheath Diameter	Resistance	Accuracy	Temperature Range	Wiring Configuration	Sheath Material	Head Type	Connection	Cable Glands	Nominal Length	Lag Extension	Process Connection	Electrical Connection	Certification	Calibration Certificate	Tag	N=xxx LN=xxx	
Ordering Code	S50	1	T	1	B	A	B	A	N	2	-	X								
Step	1	2	3	4	5	6	7	8	9	10	11	12	13	14	15	16	17	18	19	

10 Select the head mounting/instrument connection for heads with 1/2 or 3/4 NPT conduit connections.

Code	Head Mounting/Instrument Connection with 1/2 NPT Conduit Connection
2	1/2 NPT
N	3/4 NPT
M	M20 x 1.5
A	Adapter M20 x 1.5
P	Pg 16

Code	Head Mounting/Instrument Connection with 3/4 NPT Conduit Connection
3	1/2 NPT
4	3/4 NPT
5	M20 x 1.5

11 Select a cable gland.

The most common selection is “without” since most customers supply their cable glands.

Code	Head Cable Gland
-	Without
P	Polyamide PA, for unarmored cable
L	Nickel plated brass, for unarmored cable
M	Nickel plated brass, single seal for armored cable
N	Nickel plated brass, double seal for armored cable
S	Stainless steel, for unarmored cable
T	Stainless steel, single seal for armored cable
U	Stainless steel, double seal for armored cable

12 Determine the nominal length.

Nominal length (LN) is calculated by adding the lag length and probe insertion length (refer to diagram below).

In the product place an “X” here and the actual LN= is added to the end of the product code in mm.

- N = Lag Extension Length
- L = Insertion Length
- LN = Insert Nominal Length
- LN = N + L

Nominal Length X LN = (min=50, max=100000)
(add actual length LN=?? at the end of product code in mm)

Code	Nominal Length
X	Actual LN = added in end of code in mm

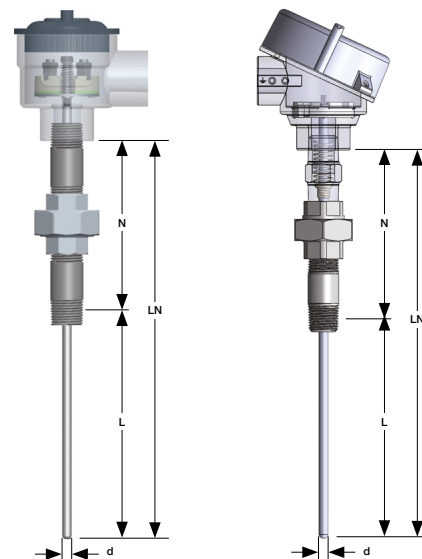

Selection Example:

	Model type	Location	Sheath Diameter	Resistance	Accuracy	Temperature Range	Wiring Configuration	Sheath Material	Head Type	Connection	Cable Glands	Nominal Length	Lag Extension	Process Connection	Electrical Connection	Certification	Calibration Certificate	Tag	N=xxx LN=xxx	
Ordering Code	S50	1	T	1	B	A	B	A	N	2	-	X	U-J7	R3						
Step	1	2	3	4	5	6	7	8	9	10	11	12	13	14	15	16	17	18	19	

13 Determine the lag extension type and length.

The length of the lag extension should be sufficient to guarantee that the ambient temperature around the connection head, transmitter and wiring does not exceed the transmitter temperature limits. DIN mounts probes use a terminal block mounted to a DIN plate with two springs that are used to mount the assembly to the head. Those springs act as a spring-loaded system on the mounting plate with approximately 13 mm (0.5") play to simplify thermowell installation applications. Spring-loaded mounts have approximately 13 mm (0.5") play as well.

Lag Extension and Length

Lag length (add actual length N=?? at the end of product code in mm)

Code	For DIN Mounting Plate
0---	Without lag extension, without plug (not available with FM explosion proof approval)
0-4-	Without lag extension, with plug
B-H6	Nipple AISI 316, N=40
M-H7	Nipple AISI 316, N=100 (4 inches)
N-H9	Nipple AISI 316, N= non std
U-J7	Nipple-Union-Nipple AISI 316, N=120
N-J9	Nipple-Union-Nipple AISI 316, N= not std
Code	For Spring-loaded Mounting (Not available with FM explosion proof approval)
N-S1	Spring-loaded Nipple AISI 316
M-S4	Spring-loaded Nipple-Union-Nipple 4" AISI 316, N=100
R-S6	Spring-loaded Nipple-Union-Nipple 6" AISI 316, N=153
N-S9	Spring-loaded Nipple-Union-Nipple AISI 316, N=not std

14 Select the process connection.

Ensure that process connection selection matches the process input or thermowell instrument connection. Thermowells are typically ½ NPT instrument connection.

Code	Process Connection
R3	Thread ½ NPT
C3	Compression fitting ½ NPT, AISI 316
A3	Compression fitting G, AISI 316 (N/A with FM approval)
--	Without connection

Selection Example:

	Model type	Location	Sheath Diameter	Resistance	Accuracy	Temperature Range	Wiring Configuration	Sheath Material	Head Type	Connection	Cable Glands	Nominal Length	Lag Extension	Process Connection	Electrical Connection	Certification	Calibration Certificate	Tag	N=xxx LN=xxx
Ordering Code	S50	1	T	1	B	A	B	A	N	2	-	X	U-J7	R3	-	-			
Step	1	2	3	4	5	6	7	8	9	10	11	12	13	14	15	16	17	18	19

15 Select the electrical connection.

The electrical connection should be selected per application requirements. The transmitter selection specifies that a transmitter is part of the assembly. However, transmitters are specified and configured separately, although installed and programmed in the probe. Please refer to the [temperature transmitter data sheet](#) to review the specifications and configure the appropriate product code.

Electrical Connection	
Code	For DIN Mounting Plate
-	With DIN terminal block
1	With transmitter (hockey puck style or digital display)
3	Without terminal block, with flying leads
Code	For Spring-loaded Mounting (N/A with FM approval)
B	With terminal block
T	With transmitter (hockey puck style or digital display)
F	Without terminal block, with flying leads

16 Determine which type of certifications is required for the application.

The certificate will be for the protection method chosen in step 2.

Code	Certifications
-	None
F	FM (USA & Canada certification)
A	ATEX
S	SIL 2 + ATEX
I	INMETRO
X	IECEX
D	ATEX + IECEX
2	SIL 2
P	EAC (Gost R) + Metrological Russia

Selection Example:

	Model type	Location	Sheath Diameter	Resistance	Accuracy	Temperature Range	Wiring Configuration	Sheath Material	Head Type	Connection	Cable Glands	Nominal Length	Lag Extension	Process Connection	Electrical Connection	Certification	Calibration Certificate	Tag	N=xxx LN=xxx
Ordering Code	S50	1	T	1	B	A	B	A	N	2	-	X	U-J7	R3	-	-	3P	T	
Step	1	2	3	4	5	6	7	8	9	10	11	12	13	14	15	16	17	18	19

17 Determine if a calibration certificate is required.

Ashcroft® RTDs and thermocouples meet the advertised specifications. However, 3-point or 5-point calibration certificates are offered for critical applications or application quality requirements. 5-point calibration is more expensive than 3-point calibration on single and double calibrations due to extra labor involved.

Code	Calibration Report
-	Without
3P	3 points for single sensor
5P	5 points for single sensor
3D	3 points for dual sensor
5D	5 points for dual sensor

18 Select a tag if it is needed.

Tags are selected to identify the instrument or system.

Code	Tags
-	Without
T	Label in stainless steel with tag

19 Review the product code you have created in steps 1 through 18.

As your final step, review the product code for accuracy.

Tip! Please make sure the N= and LN= lengths are at the end of the product code in mm.

Thank you for choosing Ashcroft for your temperature measuring applications!

2) S50 Thermocouple Direct Mount Sensor

Selection Example:

	Model Type	Location	Sheath Diameter	Thermocouple Type	Accuracy	Junction Type	Single Or Dual Sensor	Sheath Material	Head Type	Connection	Cable Glands	Nominal Length	Lag Extension	Process Connection	Electrical Connection	Certification	Calibration Certificate	Tag	N=xxx LN=xxx	
Ordering Code	S50	S	T																	
Step	1	2	3	4	5	6	7	8	9	10	11	12	13	14	15	16	17	18	19	

1 The product code configuration starts with the model type.

Code	Thermocouple Series
S50	Direct Mount Sensor

2 Select whether the sensor is used in a hazardous location or non-hazardous location.

If it is a hazardous location, select the method of protection you will need for the assembly. Later in the configuration (Step 16) you will need to decide which agency certificate is required.

Code	Area Classification
S	Standard – General purpose
J	Intrinsic Safety – ia – FM, ATEX or IECEx certificate available
B	Intrinsic Safety – ib – ATEX or IECEx certificate available
E	Increased Safety – ATEX certificate available
D	Explosion Proof (requires F or S Head Type) – FM, ATEX or IECEx certificate available
N	Non-Incendive – FM certificate available

3 Select the sheath diameter, which is also known as stem diameter.

It is critical to ensure that the probe will fit in the application nozzle or thermowell bore diameter. A typical thermowell has a 0.260" bore diameter that will perfectly fit a 1/4" sheath diameter.

Code	Sheath Diameter
T	1/4" (6.35 mm)
S	3/16" (4.76 mm)
R	1/8" (3.18 mm)
3	3 mm
4	4.5 mm
6	6 mm
8	8 mm

Selection Example:

	Model Type	Location	Sheath Diameter	Thermocouple Type	Accuracy	Junction Type	Single Or Dual Sensor	Sheath Material	Head Type	Connection	Cable Glands	Nominal Length	Lag Extension	Process Connection	Electrical Connection	Certification	Calibration Certificate	Tag	N=xxx LN=xxx	
Ordering Code	S50	S	T	K																
Step	1	2	3	4	5	6	7	8	9	10	11	12	13	14	15	16	17	18	19	

4 Select thermocouple type.

The thermocouple type should be selected to match instrument input and within the application temperature range (refer to chart below).

Thermocouple Type	Conductor		
	+	-	
Code	Base Metal Alloys		Temperature Range
T	Cu	Cu-Ni	-250 to 350 °C
J	Fe	Cu-Ni	-40 to 750 °C
E	Ni-Cr	Cu-Ni	-200 to 800 °C
K	Ni-Cr	Ni-Al	-200 to 1000 °C
N	Ni-Cr-Si	Ni-Si-Mg	-200 to 1000 °C

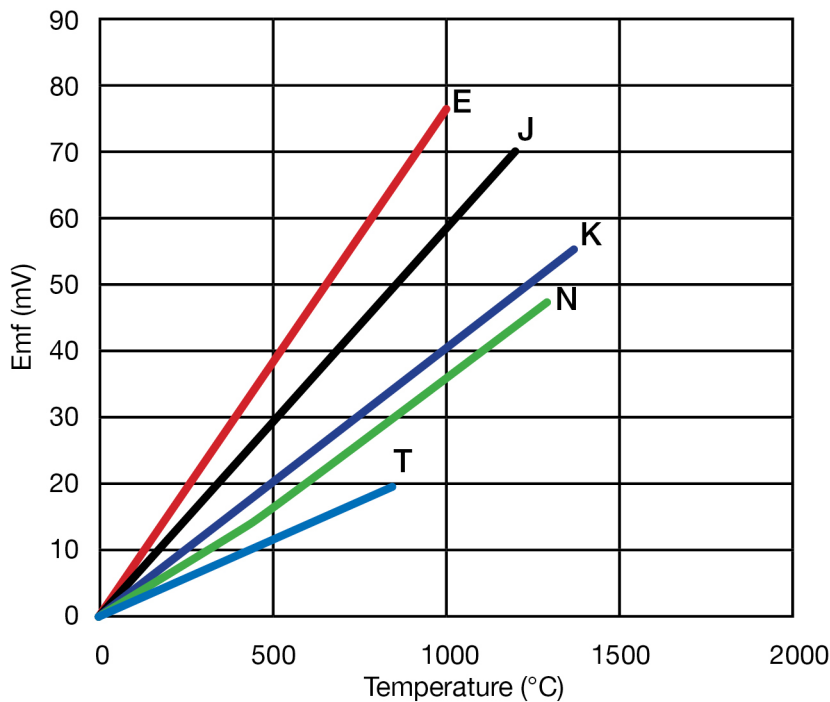

Selection Example:

	Model Type	Location	Sheath Diameter	Thermocouple Type	Accuracy	Junction Type	Single Or Dual Sensor	Sheath Material	Head Type	Connection	Cable Glands	Nominal Length	Lag Extension	Process Connection	Electrical Connection	Certification	Calibration Certificate	Tag	N=xxx LN=xxx	
Ordering Code	S50	S	T	K	N	1	1													
Step	1	2	3	4	5	6	7	8	9	10	11	12	13	14	15	16	17	18	19	

5 Select the the appropriate accuracy for your application requirements.

Standard limits accuracy is the most popular selection. However, special limits accuracy requires special wire to meet the accuracy, which increases cost and lead time.

Thermocouple (ANSI MC 96.1)						Code	TC Accuracy or Class
	Type J	Type K	Type E	Type N	Type T		
Standard	±2.2 °C or ±0.0075* t	±2.2 °C or ±0.0075* t	±1.7 °C or ±0.0050* t	±2.2 °C or ±0.0040* t	±1.0 °C or ±0.0075* t	N	ANSI MC 96.1: Standard limits
Special	±1.1 °C or ±0.0040* t	±1.1 °C or ±0.0040* t	±1.0 °C or ±0.0075* t	±1.1 °C or ±0.0040* t	±0.5 °C or ±0.0040* t	S	ANSI MC 96.1: Special limits
						1	IEC 60584-2: Class 1
						2	IEC 60584-2: Class 2
						3	IEC 60584-2: Class 3

Thermocouple (IEC 60584-2)					
	Type J	Type K	Type E	Type N	Type T
Class 1	±1.5 °C or ±0.0040* t	±1.5 °C or ±0.0040* t	±1.5 °C or ±0.0040* t	±1.5 °C or ±0.0040* t	±0.5 °C or ±0.0040* t
Class 2	±2.5 °C or ±0.0075* t	±2.5 °C or ±0.0075* t	±2.5 °C or ±0.0075* t	±2.5 °C or ±0.0075* t	±1.0 °C or ±0.0075* t
Class 3	N/A	±2.5 °C or ±0.0040* t	±2.5 °C or ±0.0150* t	±2.5 °C or ±0.0150* t	±1.0 °C or ±0.0150* t

6 Select thermocouple junction type.

Ungrounded junction thermocouples are more popular because the junction is separated and isolated from the sheath wall by a layer of MgO insulation. This isolates the circuit and prevents the signal from being interrupted by electric noise. Consequently, the accuracy of the temperature measurement is much higher. Whereas a grounded junction thermocouple is in contact with the sheath wall providing a faster response time, but it is more susceptible to electrical ground loops.

Code	Junction
1	Ungrounded
2	Grounded
3	Ungrounded, vibration-proof
4	Grounded, vibration-proof

7 Select single or dual sensors.

Single or dual circuit should be selected per application requirements.

Code	Electrical Circuit
1	Single thermocouple sensor
2	Dual thermocouple sensor

Selection Example:

	Model Type	Location	Sheath Diameter	Thermocouple Type	Accuracy	Junction Type	Single Or Dual Sensor	Sheath Material	Head Type	Connection	Cable Glands	Nominal Length	Lag Extension	Process Connection	Electrical Connection	Certification	Calibration Certificate	Tag	N=xxx LN=xxx	
Ordering Code	S50	S	T	K	N	1	1	3	N											
Step	1	2	3	4	5	6	7	8	9	10	11	12	13	14	15	16	17	18	19	

8 Select sheath material.

316 stainless steel is standard for RTD sheath material. If an exotic material is desired, we recommend that it be used on the thermowell for process comparability such as caustic media. To select the thermowell for your RTD, you can view the available options and configure the appropriate product part number [here](#).

Code	Sheath Material
1	316 Stainless steel, AISI 316L/ 1.4404
3	Inconel® 600/ 2.4816

9 Select head type.

The head type head should meet application environment and approvals restrictions. For example, only Ex d aluminum and Ex d stainless steel head type can be used when FM explosion proof approval is required.

S50 Head Selection

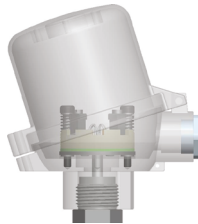

BUZH-AL
Type E

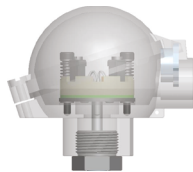

BUZH-AL
Type D

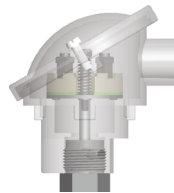

DIN B
Type B

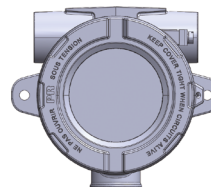

PR 7501 with display
Type P

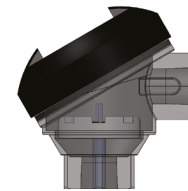

Cast Iron
Type Y

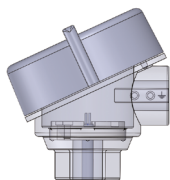

Type F Ex d-AL
Type S Ex d-Stainless Steel

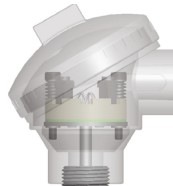

SCCA-AL
Type N

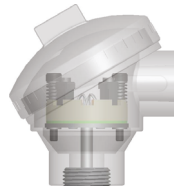

SCCI-Stainless Steel
Type G

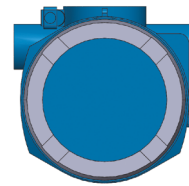

E&H Display Housing
Type H

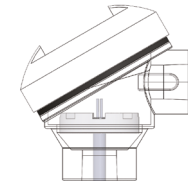

Polypropylene
Type A

Code	Head Type
E	BUZH aluminum
D	BUZ aluminum
B	DIN B aluminum
P	PR 7501
Y	Cast iron
F	Ex d aluminum
S	Ex d stainless steel
N	SCCA aluminum
G	SCCI stainless steel
H	E&H housing
A	Polypropylene

Selection Example:

	Model Type	Location	Sheath Diameter	Thermocouple Type	Accuracy	Junction Type	Single Or Dual Sensor	Sheath Material	Head Type	Connection	Cable Glands	Nominal Length	Lag Extension	Process Connection	Electrical Connection	Certification	Calibration Certificate	Tag	N=xxx LN=xxx
Ordering Code	S50	S	T	K	N	1	1	3	N	2	-	X							
Step	1	2	3	4	5	6	7	8	9	10	11	12	13	14	15	16	17	18	19

10 Select the head mounting/instrument connection for heads with 1/2 or 3/4 NPT conduit connections.

Code	Head Mounting/Instrument Connection with 1/2 NPT Conduit Connection
2	1/2 NPT
N	3/4 NPT
M	M20 x 1.5
A	Adapter M20 x 1.5
P	Pg 16

Code	Head Mounting/Instrument Connection with 3/4 NPT Conduit Connection
3	1/2 NPT
4	3/4 NPT
5	M20 x 1.5

11 Select a cable gland.

The most common selection is “without” since most customers supply their cable glands.

Code	Head Cable Gland
-	Without
P	Polyamide PA, for unarmored cable
L	Nickel plated brass, for unarmored cable
M	Nickel plated brass, single seal for armored cable
N	Nickel plated brass, double seal for armored cable
S	Stainless steel, for unarmored cable
T	Stainless steel, single seal for armored cable
U	Stainless steel, double seal for armored cable

12 Determine the nominal length.

Nominal length (LN) is calculated by adding the lag length and probe insertion length (refer to diagram below).

In the product place an “X” here and the actual LN= is added to the end of the product code in mm.

- N = Lag extension length
- L = Insertion length
- LN = Insert nominal length
- LN = N + L

Nominal Length X LN = (min=50, max=100000)
(add actual length LN=?? at the end of product code in mm)

Code	Nominal Length
X	Actual LN = added in end of code in mm

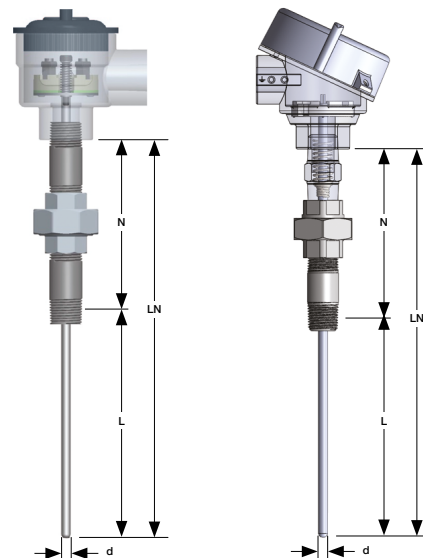

Selection Example:

	Model Type	Location	Sheath Diameter	Thermocouple Type	Accuracy	Junction Type	Single Or Dual Sensor	Sheath Material	Head Type	Connection	Cable Glands	Nominal Length	Lag Extension	Process Connection	Electrical Connection	Certification	Calibration Certificate	Tag	N=xxx LN=xxx	
Ordering Code	S50	S	T	K	N	1	1	3	N	2	-	X	U-J7	R3						
Step	1	2	3	4	5	6	7	8	9	10	11	12	13	14	15	16	17	18	19	

13 Determine the lag extension type and length.

The length of the lag extension should be sufficient to guarantee that the ambient temperature around the connection head, transmitter and wiring does not exceed the transmitter temperature limits. DIN mounts probes use a terminal block mounted to a DIN plate with two springs that are used to mount the assembly to the head. Those springs act as a spring-loaded system on the mounting plate with approximately 13 mm (0.5") play to simplify thermowell installation applications. Spring-loaded mounts have approximately 13 mm (0.5") play as well.

Lag Extension and Length

Lag length (add actual length N=?? at the end of product code in mm)

Code	For DIN Mounting Plate
0---	Without lag extension, without plug (not available with FM explosion proof approval)
0-4-	Without lag extension, with plug
B-H6	Nipple AISI 316, N=40
M-H7	Nipple AISI 316, N=100 (4 inches)
N-H9	Nipple AISI 316, N= non std
U-J7	Nipple-Union-Nipple AISI 316, N=120
N-J9	Nipple-Union-Nipple AISI 316, N= not std
Code	For Spring-loaded Mounting (Not available with FM explosion proof approval)
N-S1	Spring-loaded Nipple AISI 316
M-S4	Spring-loaded Nipple-Union-Nipple 4" AISI 316, N=100
R-S6	Spring-loaded Nipple-Union-Nipple 6" AISI 316, N=153
N-S9	Spring-loaded Nipple-Union-Nipple AISI 316, N=not std

14 Select the process connection.

Ensure that process connection selection matches the process input or thermowell instrument connection. Thermowells are typically 1/2 NPT instrument connection.

Code	Process Connection
R3	Thread 1/2 NPT
C3	Compression fitting 1/2 NPT, AISI 316
A3	Compression fitting G, AISI 316 (N/A with FM approval)
--	Without connection

Selection Example:

	Model Type	Location	Sheath Diameter	Thermocouple Type	Accuracy	Junction Type	Single Or Dual Sensor	Sheath Material	Head Type	Connection	Cable Glands	Nominal Length	Lag Extension	Process Connection	Electrical Connection	Certification	Calibration Certificate	Tag	N=xxx LN=xxx
Ordering Code	S50	S	T	K	N	1	1	3	N	2	-	X	U-J7	R3	-	-			
Step	1	2	3	4	5	6	7	8	9	10	11	12	13	14	15	16	17	18	19

15 Select the electrical connection.

The electrical connection should be selected per application requirements. The transmitter selection specifies that a transmitter is part of the assembly. However, transmitters are specified and configured separately, although installed and programmed in the probe. Please refer to the [temperature transmitter data sheet](#) to review the specifications and configure the appropriate product code.

Electrical Connection	
Code	For DIN Mounting Plate
-	With DIN terminal block
1	With transmitter (hockey puck style or digital display)
3	Without terminal block, with flying leads
Code	For Spring-Loaded Mounting (N/A with FM approval)
B	With terminal block
T	With transmitter (hockey puck style or digital display)
F	Without terminal block, with flying leads

16 Determine which type of certifications is required for the application.

The certificate will be for the protection method chosen in step 2.

Code	Certifications
-	None
F	FM (USA & Canada certification)
A	ATEX
S	SIL 2 + ATEX
I	INMETRO
X	IECEX
D	ATEX + IECEX
2	SIL 2
P	EAC (Gost R) + Metrological Russia

Selection Example:

	Model Type	Location	Sheath Diameter	Thermocouple Type	Accuracy	Junction Type	Single Or Dual Sensor	Sheath Material	Head Type	Connection	Cable Glands	Nominal Length	Lag Extension	Process Connection	Electrical Connection	Certification	Calibration Certificate	Tag	N=xxx LN=xxx
Ordering Code	S50	S	T	K	N	1	1	3	N	2	-	X	U-J7	R3	-	-	3P	T	
Step	1	2	3	4	5	6	7	8	9	10	11	12	13	14	15	16	17	18	19

17 Determine if a calibration certificate is required.

Ashcroft® RTDs and thermocouples meet the advertised specifications. However, 3-point or 5-point calibration certificates are offered for critical applications or application quality requirements. 5-point calibration is more expensive than 3-point calibration on single and double calibrations due to extra labor involved.

Code	Calibration Report
-	Without
3P	3 points for single sensor
5P	5 points for single sensor
3D	3 points for dual sensor
5D	5 points for dual sensor

18 Select a tag if it is needed.

Tags are selected to identify the instrument or system.

Code	Tags
-	Without
T	Label in stainless steel with tag

19 Review the product code you have created in steps 1 through 18.

As your final step, review the product code for accuracy.

Tip! Please make sure the N= and LN= lengths are at the end of the product code in mm.

Thank you for choosing Ashcroft for your temperature measuring applications!

3) S80 Remote Mount Assembly Thermocouple

Selection Example:

	Model Type	Location	Sheath Diameter	Thermocouple Type	Accuracy	Junction Type	Single Or Dual Sensor	Sheath Material	Wire Termination	Connector Strain Relief	Head Type	Probe Length	Cable Length	Cable Protection	Lead Wire Jacket	Lead Wire Options	Process Connection		Certification	Calibration Certificate	Tag	LC = xxx L = xxx
Ordering Code	S80	S	R															3				
Step	1	2	3	4	5	6	7	8	9	10	11	12	13	14	15	16	17		18	19	20	21

1 The product code configuration starts with the model type.

Code	Thermocouple Series
S80	Remote Mount Assembly

2 Select whether the sensor is used in a hazardous location or non-hazard location.

If it is a hazardous location, select the method of protection you will need for the assembly. Later in the configuration (Step 18) you will need to decide which agency certificate is required.

Code	Area Classification
S	Standard – General purpose
J	Intrinsic Safety – ia – FM, ATEX or IECEx certificate available
B	Intrinsic Safety – ib – ATEX or IECEx certificate available
E	Increased Safety – ATEX certificate available
N	Non-Incendive – FM certificate available

3 Select the sheath diameter, which is also known as stem diameter.

It is critical to ensure that the probe will fit in the application nozzle or thermowell bore diameter. A typical thermowell has a 0.260" bore diameter that will perfectly fit a 1/4" sheath diameter.

Code	Sheath Diameter
T	1/4" (6.35 mm)
S	3/16" (4.76 mm)
R	1/8" (3.18 mm)
3	3 mm
4	4.5 mm
6	6 mm
8	8 mm

Selection Example:

	Model Type	Location	Sheath Diameter	Thermocouple Type	Accuracy	Junction Type	Single Or Dual Sensor	Sheath Material	Wire Termination	Connector Strain Relief	Head Type	Probe Length	Cable Length	Cable Protection	Lead Wire Jacket	Lead Wire Options	Process Connection		Certification	Calibration Certificate	Tag	LC = xxx L = xxx
Ordering Code	S80	S	R	K														3				
Step	1	2	3	4	5	6	7	8	9	10	11	12	13	14	15	16	17		18	19	20	21

4 Select thermocouple type.

The thermocouple type should be selected to match instrument input and within the application temperature range (refer to chart below).

Thermocouple Type	Conductor		
	+	-	
Code	Base Metal Alloys	Temperature Range	
T	Cu	Cu-Ni	-250 to 350 °C
J	Fe	Cu-Ni	-40 to 750 °C
E	Ni-Cr	Cu-Ni	-200 to 800 °C
K	Ni-Cr	Ni-Al	-200 to 1000 °C
N	Ni-Cr-Si	Ni-Si-Mg	-200 to 1000 °C

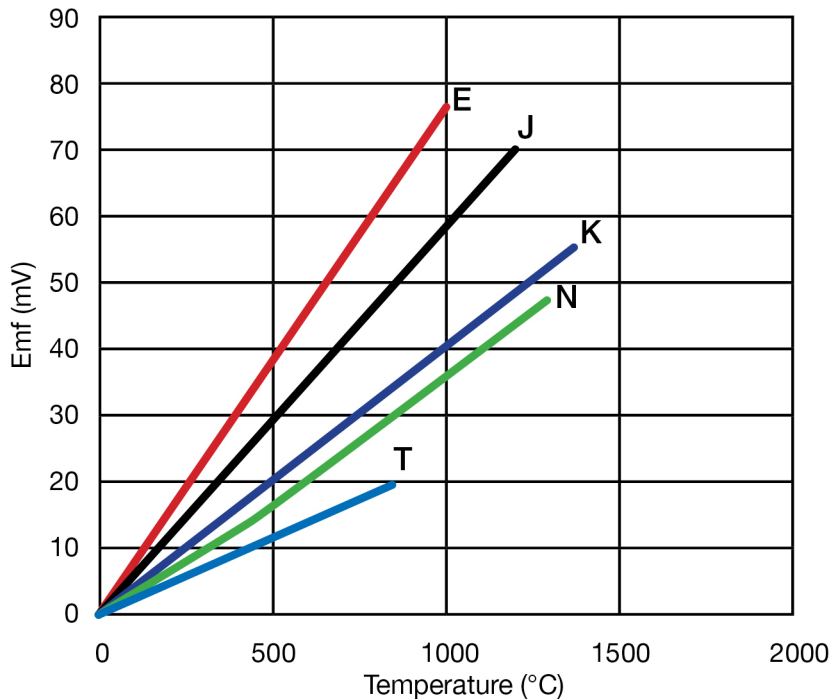

Selection Example:

	Model Type	Location	Sheath Diameter	Thermocouple Type	Accuracy	Junction Type	Single Or Dual Sensor	Sheath Material	Wire Termination	Connector Strain Relief	Head Type	Probe Length	Cable Length	Cable Protection	Lead Wire Jacket	Lead Wire Options	Process Connection		Certification	Calibration Certificate	Tag	LC = xxx L = xxx
Ordering Code	S80	S	R	K	N	1	1											3				
Step	1	2	3	4	5	6	7	8	9	10	11	12	13	14	15	16	17		18	19	20	21

5 Select the the appropriate accuracy for your application requirements.

Standard limits accuracy is the most popular selection. However, special limits accuracy requires special wire to meet the accuracy, which increases cost and lead time.

Thermocouple (ANSI MC 96.1)						Code	TC Accuracy or Class
	Type J	Type K	Type E	Type N	Type T		
Standard	±2.2 °C or ±0.0075* t	±2.2 °C or ±0.0075* t	±1.7 °C or ±0.0050* t	±2.2 °C or ±0.0040* t	±1.0 °C or ±0.0075* t	N	ANSI MC 96.1: Standard limits
Special	±1.1 °C or ±0.0040* t	±1.1 °C or ±0.0040* t	±1.0 °C or ±0.0075* t	±1.1 °C or ±0.0040* t	±0.5 °C or ±0.0040* t	S	ANSI MC 96.1: Special limits
						1	IEC 60584-2: Class 1
						2	IEC 60584-2: Class 2
						3	IEC 60584-2: Class 3

Thermocouple (IEC 60584-2)					
	Type J	Type K	Type E	Type N	Type T
Class 1	±1.5 °C or ±0.0040* t	±1.5 °C or ±0.0040* t	±1.5 °C or ±0.0040* t	±1.5 °C or ±0.0040* t	±0.5 °C or ±0.0040* t
Class 2	±2.5 °C or ±0.0075* t	±2.5 °C or ±0.0075* t	±2.5 °C or ±0.0075* t	±2.5 °C or ±0.0075* t	±1.0 °C or ±0.0075* t
Class 3	N/A	±2.5 °C or ±0.0040* t	±2.5 °C or ±0.0150* t	±2.5 °C or ±0.0150* t	±1.0 °C or ±0.0150* t

6 Select thermocouple junction type.

Ungrounded junction thermocouples are more popular because the junction is separated and isolated from the sheath wall by a layer of MgO insulation. This isolates the circuit and prevents the signal from being interrupted by electric noise. Consequently, the accuracy of the temperature measurement is much higher. Whereas a grounded junction thermocouple is in contact with the sheath wall providing a faster response time, but it is more susceptible to electrical ground loops.

Code	Junction
1	Ungrounded
2	Grounded
3	Ungrounded, vibration-proof
4	Grounded, vibration-proof

7 Select single or dual sensors.

Single or dual circuit should be selected per application requirements.

Code	Electrical Circuit
1	Single thermocouple sensor
2	Dual thermocouple sensor

Selection Example:

	Model Type	Location	Sheath Diameter	Thermocouple Type	Accuracy	Junction Type	Single Or Dual Sensor	Sheath Material	Wire Termination	Connector Strain Relief	Head Type	Probe Length	Cable Length	Cable Protection	Lead Wire Jacket	Lead Wire Options	Process Connection		Certification	Calibration Certificate	Tag	LC = xxx L = xxx
Ordering Code	S80	S	R	K	N	1	1	3	3	2								3				
Step	1	2	3	4	5	6	7	8	9	10	11	12	13	14	15	16	17		18	19	20	21

8 Select sheath material.

316L stainless steel is less expensive; however, Inconel® is more popular on Type K thermocouples.

Code	Sheath Material
1	AISI 316 Stainless steel/ 1.4404
3	Inconel® 600/ 2.4816

9 Select wire termination per application requirements.

Code	Wire Termination
7	Stripped end
3	With miniature male connector
4	With miniature male and female connector
5	With standard male connector
6	With standard male and female connector
A	Std plain stripped leads (1-½")
B	Spade lugs #8
C	¼" Push on connector
D	With miniature female connector
E	With miniature female and additional male connector
F	With standard female connector
G	With standard female and additional male connector

10 Select connector strain relief per application requirements..

Code	Connector Strain Relief
-	Non-applicable (no connector)
1	Crimp - Braze adapter (for use with flex armor and no wire options)
2	Grommet - for regular wire option, with no flex armor
3	Bracket - for regular wire option, with no flex armor

Selection Example:

	Model Type	Location	Sheath Diameter	Thermocouple Type	Accuracy	Junction Type	Single Or Dual Sensor	Sheath Material	Wire Termination	Connector Strain Relief	Head Type	Probe Length	Cable Length	Cable Protection	Lead Wire Jacket	Lead Wire Options	Process Connection	Certification	Calibration Certificate	Tag	LC = xxx L = xxx
Ordering Code	S80	S	R	K	N	1	1	3	3	2	-						3				
Step	1	2	3	4	5	6	7	8	9	10	11	12	13	14	15	16	17	18	19	20	21

11 Select a remote head type head if needed.

The selection should meet application environment and approvals restrictions.

S80 Head Selection

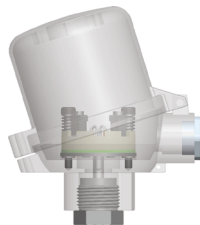

BUZH-AL
Type E

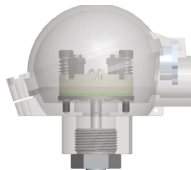

BUZH-AL
Type D

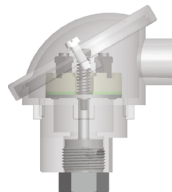

DIN B
Type B

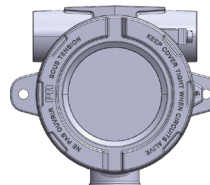

PR 7501 with display
Type P

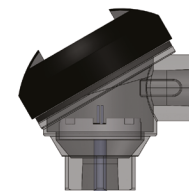

Cast Iron
Type Y

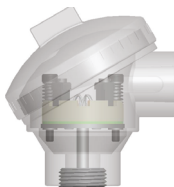

SCCA-AL
Type N

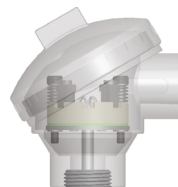

SCCI-Stainless Steel
Type G

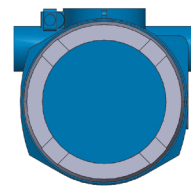

E&H Display Housing
Type H

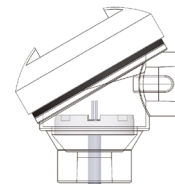

Polypropylene
Type A

Code	Remote Head Type
-	Non-applicable (no remote head)
G	SCCI stainless steel
N	SCCA aluminum
B	DIN B aluminum
D	BUZ aluminum
E	BUZH aluminum
P	PR 7501
Y	Cast iron
A	Polypropylene
H	E&H housing

Selection Example:

	Model Type	Location	Sheath Diameter	Thermocouple Type	Accuracy	Junction Type	Single Or Dual Sensor	Sheath Material	Wire Termination	Connector Strain Relief	Head Type	Probe Length	Cable Length	Cable Protection	Lead Wire Jacket	Lead Wire Options	Process Connection	Certification	Calibration Certificate	Tag	LC = xxx L = xxx	
Ordering Code	S80	S	R	K	N	1	1	3	3	2	-	X					3					
Step	1	2	3	4	5	6	7	8	9	10	11	12	13	14	15	16	17	18	19	20	21	

12 Select probe length per application requirements.

In the product code place an "X" here and the actual L= is added to the end of the product code in mm.

How to order S80 Temperature Probes:

- 1) The ordering code is built by selecting the appropriate configuration for the various sections of the ordering code.
- 2) The insert nominal length L is measured from top of the cable transition piece or center of threads to the tip of the probe.
- 3) The lead wire length LC is measured for the base of the lead wire transition piece to the end of the lead wire jacket.
- 4) The L length and the LC length are added to the end of the ordering code in millimeters.
- 5) To convert inches to millimeters multiply by 25.4. $mm = inches \times 25.4$

Custom configurations are available.

- d = Stem diameter
- LC = Length lead wire
- L = Insertion length

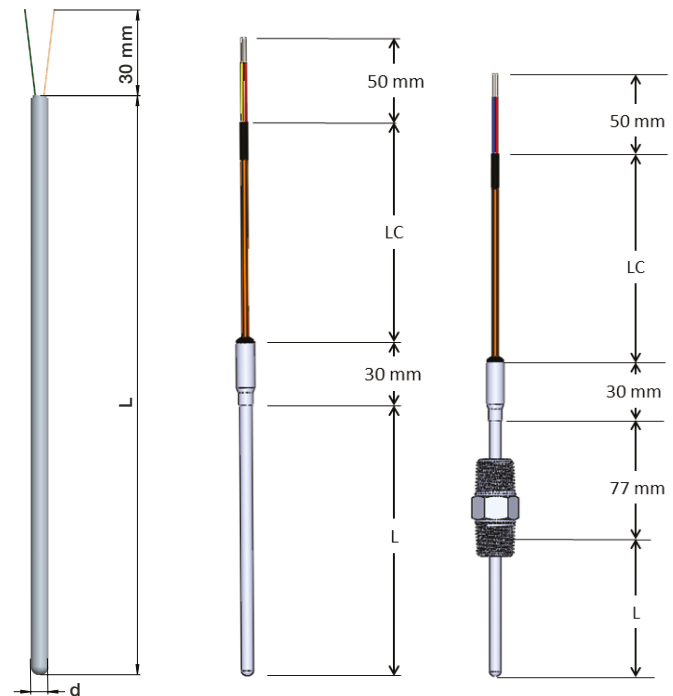

Code	Probe Length
X	L= (min=50, max=10000) (add actual length in mm L=? at the end of product code in mm)

Selection Example:

	Model Type	Location	Sheath Diameter	Thermocouple Type	Accuracy	Junction Type	Single Or Dual Sensor	Sheath Material	Wire Termination	Connector Strain Relief	Head Type	Probe Length	Cable Length	Cable Protection	Lead Wire Jacket	Lead Wire Options	Process Connection		Certification	Calibration Certificate	Tag	LC = xxx L = xxx
Ordering Code	S80	S	R	K	N	1	1	3	3	2	-	X	X	-	O	M		3				
Step	1	2	3	4	5	6	7	8	9	10	11	12	13	14	15	16	17		18	19	20	21

13 Select cable length application requirements.

In the product code place an “X” here and the actual LC= is added to the end of the product code in mm.

Code	Length Cable
X	LC=_ (min=100, max=10000) (add actual length in mm LC=?? at the end of product code in mm)

14 Select if cable protection is needed per application requirements.

Code	Flex Armor
-	Without
1	With flex armor
2	Flex armor with PVC jacket

15 Select lead wire jacket per application requirements.

Code	Lead Wire
-	Without
M	PVC
N	Silicon
O	PTFE
P	Fiberglass

16 Select options for the lead wire per application requirements.

Code	Lead Wire Options
-	Without
N	Without protective spring on lead wire
M	With protective spring on lead wire
O	Electrically shielded, with protective spring
P	Electrically shielded, without protective spring
Q	With stainless steel braided cover, with protective spring
R	With stainless steel braided cover, without protective spring

Selection Example:

	Model Type	Location	Sheath Diameter	Thermocouple Type	Accuracy	Junction Type	Single Or Dual Sensor	Sheath Material	Wire Termination	Connector Strain Relief	Head Type	Probe Length	Cable Length	Cable Protection	Lead Wire Jacket	Lead Wire Options	Process Connection		Certification	Calibration Certificate	Tag	LC = xxx L = xxx	
Ordering Code	S80	S	R	K	N	1	1	3	3	2	-	X	X	-	O	M	C3	3	-				
Step	1	2	3	4	5	6	7	8	9	10	11	12	13	14	15	16	17		18	19	20	21	

17 Select the proper process connection.

It's critical to match the process input or thermowell instrument connection. Thermowells are typically 1/2 NPT instrument connection.

Code	Process Connection
--	Without connection
C1	Compression fitting 1/4 NPT, AISI 316
C3	Compression fitting 1/2 NPT, AISI 316
A1	Compression fitting G 1/4 AISI 316
A3	Compression fitting G 1/2 AISI 316
C2	Adjustable compression fitting, with gland TFE 1/4 AISI 316
C4	Adjustable compression fitting, with gland TFE 1/2 AISI 316
B2	Adjustable compression fitting, with gland TFE 1/4 brass
B4	Adjustable compression fitting, with gland TFE 1/2 brass
B1	Non-adjustable compression fitting 1/4 NPT, brass
B3	Non-adjustable compression fitting 1/2 NPT, brass
Y1	Adjustable spring-loaded, double thread 1/2 NPT, AISI 316

Add 3 as a place holder in the ordering code

18 Determine which type of certifications is required for the application.

The certificate will be for the protection method chosen in step 2.

Code	Certifications
-	None
F	FM (USA & Canada certification)
A	ATEX
S	SIL 2 + ATEX
I	INMETRO
X	IECEX
D	ATEX + IECEX
2	SIL 2
P	EAC (Gost R) + Metrological Russia

Selection Example:

	Model Type	Location	Sheath Diameter	Thermocouple Type	Accuracy	Junction Type	Single Or Dual Sensor	Sheath Material	Wire Termination	Connector Strain Relief	Head Type	Probe Length	Cable Length	Cable Protection	Lead Wire Jacket	Lead Wire Options	Process Connection		Certification	Calibration Certificate	Tag	LC = xxx L = xxx
Ordering Code	S80	S	R	K	N	1	1	3	3	2	-	X	X	-	O	M	C3	3	-	3P	T	
Step	1	2	3	4	5	6	7	8	9	10	11	12	13	14	15	16	17		18	19	20	21

19 Determine if a calibration certificate is required.

Ashcroft® RTDs and thermocouples meet the advertised specifications. However, 3-point or 5-point calibration certificates are offered for critical applications or application quality requirements. 5-point calibration is more expensive than 3-point calibration on single and double calibrations due to extra labor involved.

Code	Calibration Report
-	Without
3P	3 points for single sensor
5P	5 points for single sensor
3D	3 points for dual sensor
5D	5 points for dual sensor

20 Select a tag if it is needed.

Tags are selected to identify the instrument or system.

Code	Tags
-	Without
T	Label in stainless steel with tag

21 Review the product code you have created in steps 1 through 20.

As your final step, review the product code for accuracy.

Tip! Please make sure the LC= and L= lengths are at the end of the product code in mm.

Thank you for choosing Ashcroft for your temperature measuring applications!

4) S81 Remote Mount Assembly RTD

Selection Example:

	Model Type	Location	Sheath Diameter	Rtd Resistance	Accuracy	Temperature Range	Wiring Configuration	Sheath Material	Wire Termination	Connector Strain Relief	Head Type	Probe Length	Cable Length	Cable Protection	Lead Wire Jacket	Lead Wire Options	Process Connection		Certification	Calibration Certificate	Tag	LC = xxx L = xxx
Ordering Code	S81	1	T															3				
Step	1	2	3	4	5	6	7	8	9	10	11	12	13	14	15	16	17		18	19	20	21

1 The product code configuration starts with the model type.

Code	RTD Series
S81	Remote Mount Assembly

2 Select whether the sensor is used in a hazardous location or non-hazardous location.

If it is a hazardous location, select the method of protection you will need for the assembly. Later in the configuration (Step 18) you will need to decide which agency certificate is required.

Code	Area Classification
1	Standard – General purpose
3	Intrinsic Safety – ia – FM, ATEX or IECEx certificate available
B	Intrinsic Safety – ib – ATEX or IECEx certificate available
E	Increased Safety – ATEX certificate available
N	Non-Incendive – FM certificate available

3 Select the sheath diameter, which is also known as stem diameter.

It is critical to ensure that the probe will fit in the application nozzle or thermowell bore diameter. A typical thermowell has a 0.260" bore diameter that will perfectly fit a ¼" sheath diameter.

Code	Sheath Diameter
T	¼" (6.35 mm)
S	3/16" (4.76 mm)
R	1/8" (3.18 mm) – single RTD sensor only
3	3 mm – single RTD sensor only
4	4.5 mm
6	6 mm

Selection Example:

	Model Type	Location	Sheath Diameter	RTD Resistance	Accuracy	Temperature Range	Wiring Configuration	Sheath Material	Wire Termination	Connector Strain Relief	Head Type	Probe Length	Cable Length	Cable Protection	Lead Wire Jacket	Lead Wire Options	Process Connection		Certification	Calibration Certificate	Tag	LC = xxx L = xxx
Ordering Code	S81	1	T	1													3					
Step	1	2	3	4	5	6	7	8	9	10	11	12	13	14	15	16	17		18	19	20	21

4 Select the RTD resistance.

Typically, the Pt 100 (100 ohm) is the most popular sensor, but the Pt 1000 (1000 ohm) can be used interchangeably depending on the instrument used. In some instances, the Pt 1000 will have better performance and accuracy.

Metal	RTD Types
Nickel	Nickel RTDs are less expensive than platinum and have good corrosion resistance. However, nickel ages more rapidly over time and loses accuracy at higher temperatures. Nickel is limited to a measurement range of -80 to 260 °C.
Platinum	Pt100 has excellent corrosion resistance, excellent long-term stability, and measures a wide range of temperature, -200 to 850 °C.

Code	RTD Type
1	Pt 100
2	Ni 120
3	Pt 1000

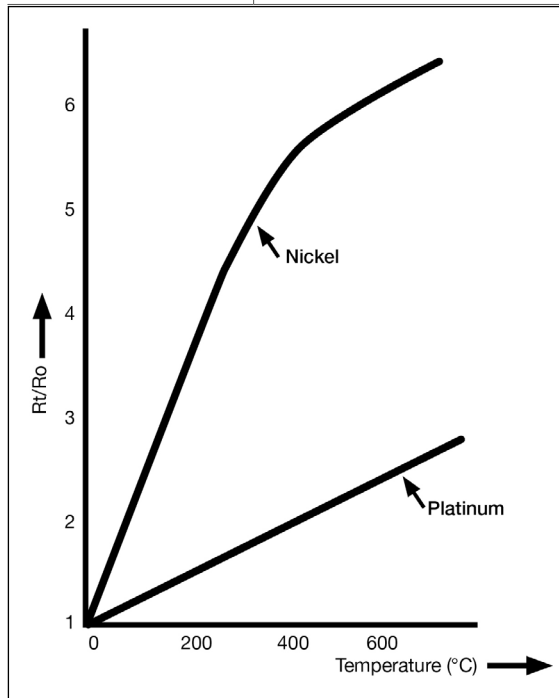

Selection Example:

	Model Type	Location	Sheath Diameter	Rtd Resistance	Accuracy	Temperature Range	Wiring Configuration	Sheath Material	Wire Termination	Connector Strain Relief	Head Type	Probe Length	Cable Length	Cable Protection	Lead Wire Jacket	Lead Wire Options	Process Connection		Certification	Calibration Certificate	Tag	LC = xxx L = xxx
Ordering Code	S81	1	T	1	B	B												3				
Step	1	2	3	4	5	6	7	8	9	10	11	12	13	14	15	16	17		18	19	20	21

5 Select the the appropriate accuracy for your application requirements.

RTDs accuracy class A and Class B are the most common accuracy classes. The accuracy class has an associated temperature range for either the wire wound or thin film RTD selected in the next step.

Code	RTD Accuracy or Class (IEC 60751)
A	Class A ((Thin film resistor -30 to 300 °C (-22 to 572 °F)), ((wire wound -100 to 450 °C (-148 to 842 °F))
B	Class B 0 to 400 °C ((Thin film resistor -50 to 500 °C (-58 to 930 °F)), ((wire wound -196 to 600 °C (-320 to 1112 °F))
C	½ DIN
D	Class AA - ⅓ DIN

Accuracy Class

RTDs - (IEC 60751)

Class A: $\pm(0.15 + 0.0020 * |t|)$

Class B: $\pm(0.30 + 0.0050 * |t|)$

½ Class B: $\pm(0.15 + 0.0025 * |t|)$

⅓ Class B: $\pm(0.10 + 0.0017 * |t|)$

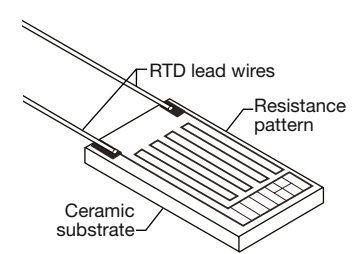

Thin Film RTD

Class B	-50 °C to 500° C (-58 °F to 930 °F)
Class A	-30 °C to 300° C (-22 °F to 572 °F)
Class AA	0 °C to 150° C (32 °F to 302 °F)

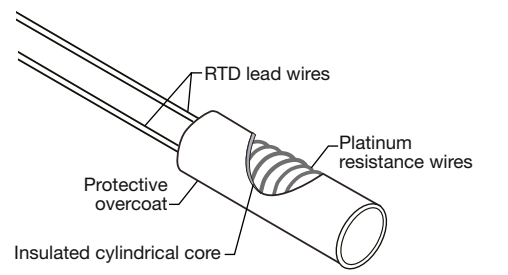

Wire Wound

Class B	-196 °C to 600° C (-320 °F to 1112 °F)
Class A	-100 °C to 450° C (-148 °F to 842 °F)
Class AA	-50 °C to 250° C (-58 °F to 482 °F)

6 Select the operating temperature range.

If the temperature range is -50 to 400 °C, you should select the thin film resistor for best results. However, if the temperature range is -200 to 600 °C, then a wire wound resistor would be best.

Code	RTD Type
A	-50 °C to 400 °C (thin film resistor)
B	-200 °C to 600 °C (wire wound resistor)
D	Vibration-proof (wire wound resistor)

Selection Example:

	Model Type	Location	Sheath Diameter	Rtd Resistance	Accuracy	Temperature Range	Wiring Configuration	Sheath Material	Wire Termination	Connector Strain Relief	Head Type	Probe Length	Cable Length	Cable Protection	Lead Wire Jacket	Lead Wire Options	Process Connection		Certification	Calibration Certificate	Tag	LC = xxx L = xxx
Ordering Code	S81	1	T	1	B	B	B											3				
Step	1	2	3	4	5	6	7	8	9	10	11	12	13	14	15	16	17		18	19	20	21

7 Select wiring configuration and whether it is a single or dual sensor probe.

It's important to select the correct RTD wire configuration because it will impact system accuracy.

2-Wire Connection

2-wire RTD configuration is the least accurate since wire resistance is included in the measurement. 2-wire RTDs are usually used with short lead wires or where accuracy is not essential. The wire resistance R2 and R3 are in the measured value.

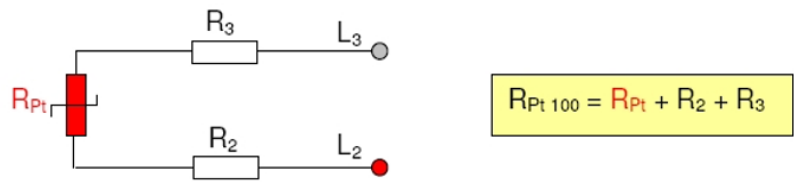

3-Wire Connection

3-wire configuration is the most used in industrial applications where the third wire provides a method for removing the average lead wire resistance from the measurement. Only if the wire resistance R1, R2 and R3 are equal do you measure the true PT 100 resistance

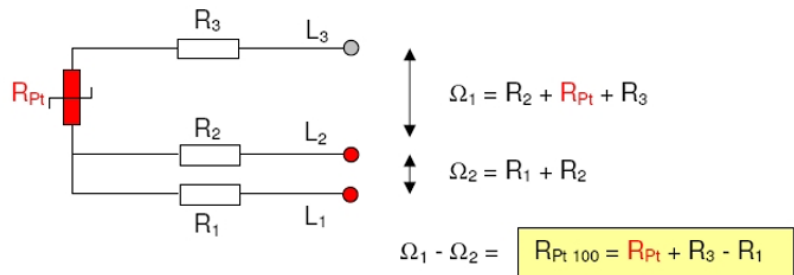

4-Wire Connection

4-wire configuration cancels lead wire resistance error. 4-wire construction is used primarily for laboratory applications where close accuracy is required. The current source will maintain the excitation current constantly (0.1-1mA). Following Ohm's law, $R=V/I$, the resistance can be calculated. The digital volt meter, DVM, has an input impedance of at least 10 Mohms. Thus just an extremely small current will pass through the DVM which means that the voltage drops over the wire resistances R2 and R3 will be practically none.

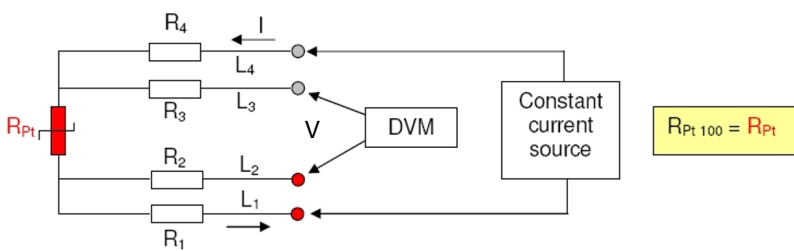

Code	Single/Dual
A	Single 2-wire
B	Single 3-wire
C	Single 4-wire
D	Dual 2-wire
E	Dual 3-wire
F	Dual 4-wire

Selection Example:

	Model Type	Location	Sheath Diameter	Rtd Resistance	Accuracy	Temperature Range	Wiring Configuration	Sheath Material	Wire Termination	Connector Strain Relief	Head Type	Probe Length	Cable Length	Cable Protection	Lead Wire Jacket	Lead Wire Options	Process Connection		Certification	Calibration Certificate	Tag	LC = xxx L = xxx
Ordering Code	S81	1	T	1	B	B	B	A	7	-								3				
Step	1	2	3	4	5	6	7	8	9	10	11	12	13	14	15	16	17		18	19	20	21

8 Select sheath material.

316 stainless steel is standard for RTD sheath material. If an exotic material is desired, we recommend that it be used on the thermowell for process comparability such as caustic media. To select the thermowell for your RTD, you can view the available options and configure the appropriate product part number [here](#).

Code	Sheath Material
A	316 Stainless steel, AISI 316/ 1.4404

9 Select wire termination per application requirements.

Code	Wire Termination
7	Stripped
8	With flat pin
9	With round pin
F	With plug LEMO type FFA.1S
P	With socket LEMO type PCA.1S
D	With plug and socket LEMO on inset

10 Select connector strain relief per application requirements..

Code	Connector Strain Relief
-	Non-applicable (no connector)
1	Crimp - Braze adapter (for use with flex armor and no wire options)
2	Grommet - for regular wire option, with no flex armor
3	Bracket - for regular wire option, with no flex armor

Selection Example:

	Model Type	Location	Sheath Diameter	Rtd Resistance	Accuracy	Temperature Range	Wiring Configuration	Sheath Material	Wire Termination	Connector Strain Relief	Head Type	Probe Length	Cable Length	Cable Protection	Lead Wire Jacket	Lead Wire Options	Process Connection	Certification	Calibration Certificate	Tag	LC = xxx L = xxx
Ordering Code	S81	1	T	1	B	B	B	A	7	-	N						3				
Step	1	2	3	4	5	6	7	8	9	10	11	12	13	14	15	16	17	18	19	20	21

11 Select a remote head type head if needed.

The selection should meet application environment and approvals restrictions.

S81 Head Selection

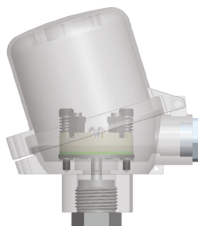

BUZH-AL
Type E

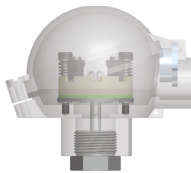

BUZH-AL
Type D

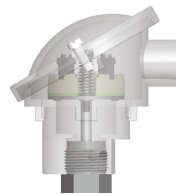

DIN B
Type B

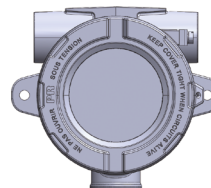

PR 7501 with display
Type P

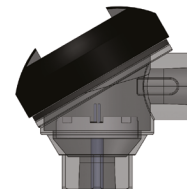

Cast Iron
Type Y

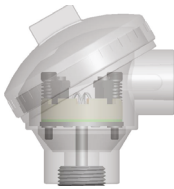

SCCA-AL
Type N

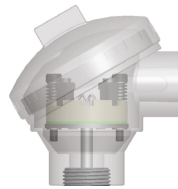

SCCI-Stainless Steel
Type G

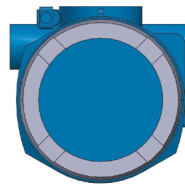

E&H Display Housing
Type H

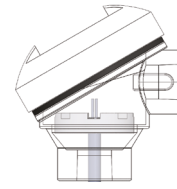

Polypropylene
Type A

Code	Remote Head Type
-	Non-applicable (no remote head)
G	SCCI stainless steel
N	SCCA aluminum
B	DIN B aluminum
D	BUZ aluminum
E	BUZH aluminum
P	PR 7501
Y	Cast iron
A	Polypropylene
H	E&H housing

Selection Example:

	Model Type	Location	Sheath Diameter	Rtd Resistance	Accuracy	Temperature Range	Wiring Configuration	Sheath Material	Wire Termination	Connector Strain Relief	Head Type	Probe Length	Cable Length	Cable Protection	Lead Wire Jacket	Lead Wire Options	Process Connection	Certification	Calibration Certificate	Tag	LC = xxx L = xxx	
Ordering Code	S81	1	T	1	B	B	B	A	7	-	N	X	X	-				3				
Step	1	2	3	4	5	6	7	8	9	10	11	12	13	14	15	16	17	18	19	20	21	

12 Select probe length per application requirements.

In the product code place an "X" here and the actual L= is added to the end of the product code in mm.

How to order S81 Temperature Probes:

- 1) The ordering code is built by selecting the appropriate configuration for the various sections of the ordering code.
- 2) The insert nominal length L is measured from top of the cable transition piece or center of threads to the tip of the probe.
- 3) The lead wire length LC is measured for the base of the lead wire transition piece to the end of the lead wire jacket.
- 4) The L length and the LC length are added to the end of the ordering code in millimeters.
- 5) To convert inches to millimeters multiply by 25.4. $mm = inches \times 25.4$

Custom configurations are available.

- d = Stem diameter
- LC = Length lead wire
- L = Insertion length

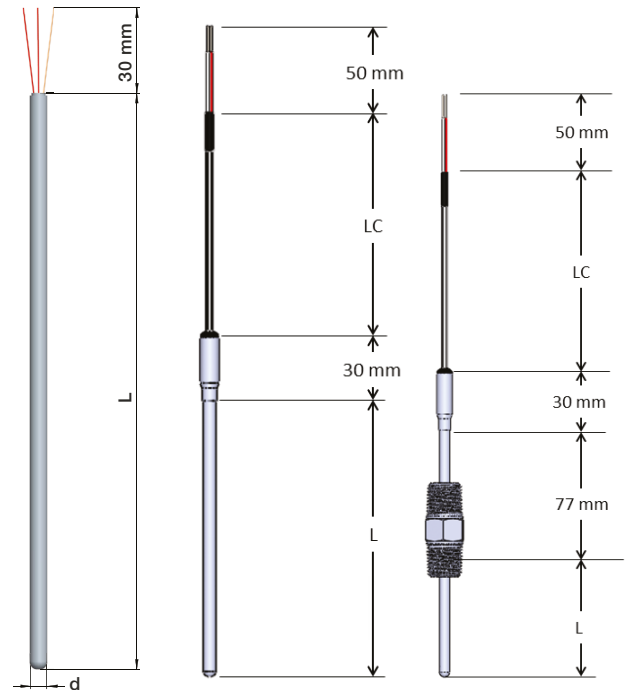

Code	Probe Cable
X	L=_ (min=50, max=10000) (add actual length in mm L=?? at the end of product code in mm)

13 Select cable length application requirements.

In the product code place an "X" here and the actual LC= is added to the end of the product code in mm.

Code	Length Cable
X	LC=_ (min=100, max=10000) (add actual length in mm LC=?? at the end of product code in mm)

14 Select if cable protection is needed per application requirements.

Code	Flex Armor
-	Without
1	With flex armor
2	Flex armor with PVC jacket

Selection Example:

	Model Type	Location	Sheath Diameter	Rtd Resistance	Accuracy	Temperature Range	Wiring Configuration	Sheath Material	Wire Termination	Connector Strain Relief	Head Type	Probe Length	Cable Length	Cable Protection	Lead Wire Jacket	Lead Wire Options	Process Connection		Certification	Calibration Certificate	Tag	LC = xxx L = xxx
Ordering Code	S81	1	T	1	B	B	B	A	7	-	N	X	X	-	O	Q	Y1	3				
Step	1	2	3	4	5	6	7	8	9	10	11	12	13	14	15	16	17		18	19	20	21

15 Select lead wire jacket per application requirements.

Code	Lead Wire
-	Without
M	PVC
N	Silicon
O	PTFE
P	Fiberglass

16 Select options for the lead wire per application requirements.

Code	Lead Wire Options
-	Without
N	Without protective spring on lead wire
M	With protective spring on lead wire
O	Electrically shielded, with protective spring
P	Electrically shielded, without protective spring
Q	With stainless steel braided cover, with protective spring
R	With stainless steel braided cover, without protective spring

17 Select the proper process connection.

It's critical to match the process input or thermowell instrument connection. Thermowells are typically ½ NPT instrument connection.

Code	Process Connection
--	Without connection
C1	Compression fitting ¼ NPT, AISI 316
C3	Compression fitting ½ NPT, AISI 316
A1	Compression fitting G ¼ AISI 316
A3	Compression fitting G ½ AISI 316
C2	Adjustable compression fitting, with gland TFE ¼ AISI 316
C4	Adjustable compression fitting, with gland TFE ½ AISI 316
B2	Adjustable compression fitting, with gland TFE ¼ brass
B4	Adjustable compression fitting, with gland TFE ½ brass
B1	Non-adjustable compression fitting ¼ NPT, brass
B3	Non-adjustable compression fitting ½ NPT, brass
Y1	Adjustable spring-loaded, double thread ½ NPT, AISI 316

Selection Example:

	Model Type	Location	Sheath Diameter	Rtd Resistance	Accuracy	Temperature Range	Wiring Configuration	Sheath Material	Wire Termination	Connector Strain Relief	Head Type	Probe Length	Cable Length	Cable Protection	Lead Wire Jacket	Lead Wire Options	Process Connection		Certification	Calibration Certificate	Tag	LC = xxx L = xxx
Ordering Code	S81	1	T	1	B	B	B	A	7	-	N	X	X	-	O	Q	Y1	3	-	3P	T	
Step	1	2	3	4	5	6	7	8	9	10	11	12	13	14	15	16	17		18	19	20	21

Add 3 as a place holder in the ordering code

18 Determine which type of certifications is required for the application.

The certificate will be for the protection method chosen in step 2.

Code	Certifications
-	None
F	FM (USA & Canada certification)
A	ATEX
S	SIL 2 + ATEX
I	INMETRO
X	IECEX
D	ATEX + IECEX
2	SIL 2
P	EAC (Gost R) + Metrological Russia

19 Determine if a calibration certificate is required.

Ashcroft® RTDs and thermocouples meet the advertised specifications. However, 3-point or 5-point calibration certificates are offered for critical applications or application quality requirements. 5-point calibration is more expensive than 3-point calibration on single and double calibrations due to extra labor involved.

Code	Calibration Report
-	Without
3P	3 points for single sensor
5P	5 points for single sensor
3D	3 points for dual sensor
5D	5 points for dual sensor

20 Select a tag if it is needed.

Tags are selected to identify the instrument or system.

Code	Tags
-	Without
T	Label in stainless steel with tag

Selection Example:

	Model Type	Location	Sheath Diameter	Rtd Resistance	Accuracy	Temperature Range	Wiring Configuration	Sheath Material	Wire Termination	Connector Strain Relief	Head Type	Probe Length	Cable Length	Cable Protection	Lead Wire Jacket	Lead Wire Options	Process Connection		Certification	Calibration Certificate	Tag	LC = xxx L = xxx
Ordering Code	S81	1	T	1	B	B	B	A	7	-	N	X	X	-	O	Q	Y1	3	-	3P	T	
Step	1	2	3	4	5	6	7	8	9	10	11	12	13	14	15	16	17		18	19	20	21

21 Review the product code you have created in steps 1 through 20.

As your final step, review the product code for accuracy.

Tip! Please make sure the LC= and L= lengths are at the end of the product code in mm.

Thank you for choosing Ashcroft for your temperature measuring applications!

Learn more about Ashcroft instrumentation
by visiting our website:

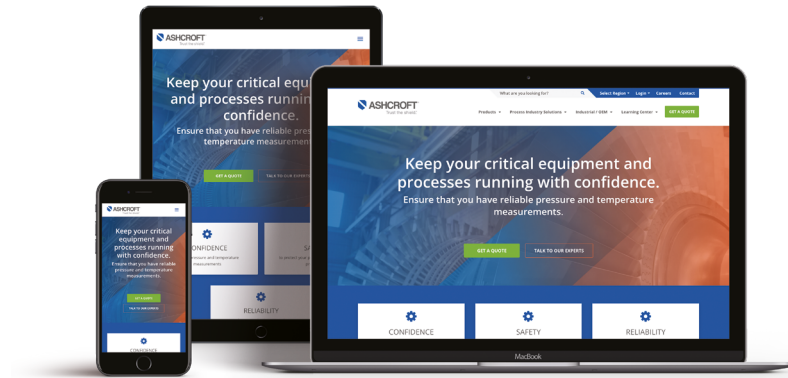

ashcroft.com

Keep your critical equipment and processes running with confidence.

Process, industrial and manufacturing companies need quality pressure and temperature measurements to keep their critical equipment and processes running. Understanding that your business can't stop, Ashcroft designs and manufactures reliable instrumentation to meet the most challenging applications worldwide so you can confidently run your business.

For more information about pressure and temperature measurement solutions, please [contact us](#) to discuss your specific requirements.